

o o

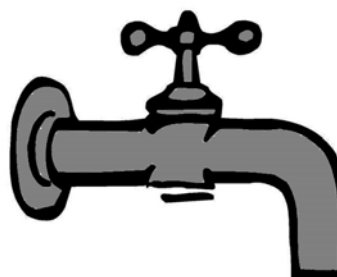

e e

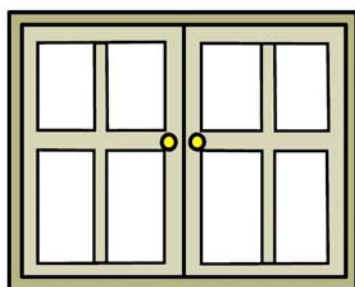

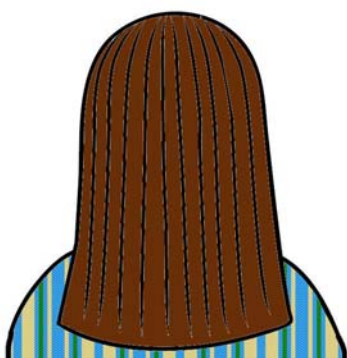
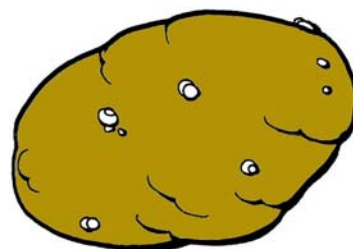
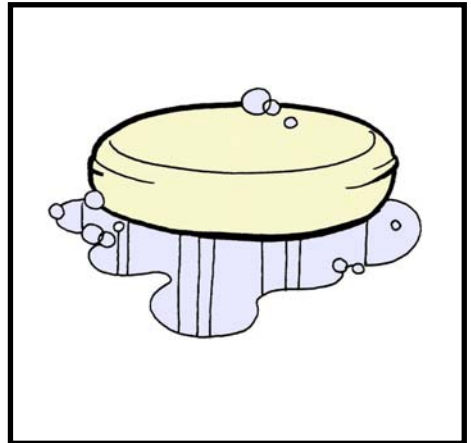
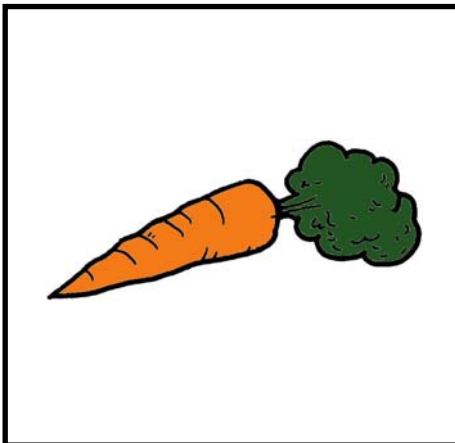
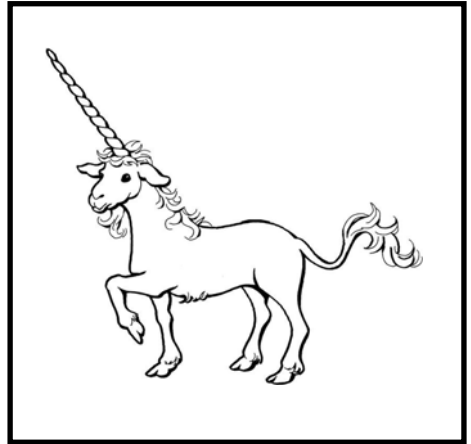
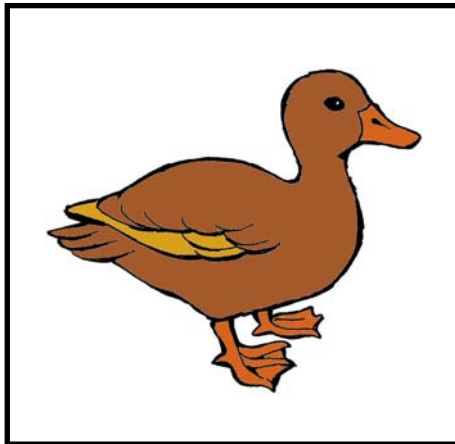
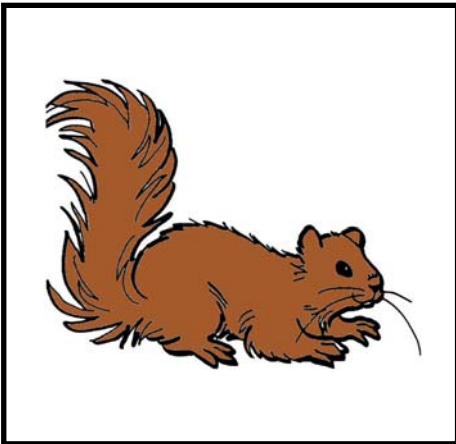
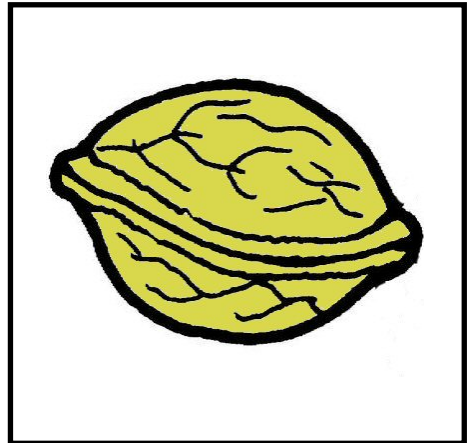
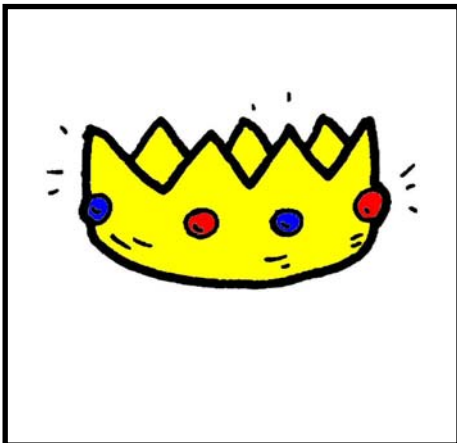
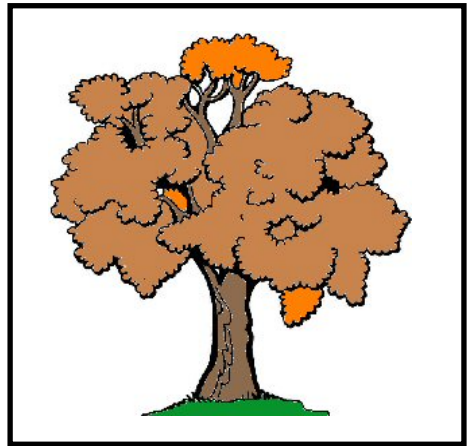
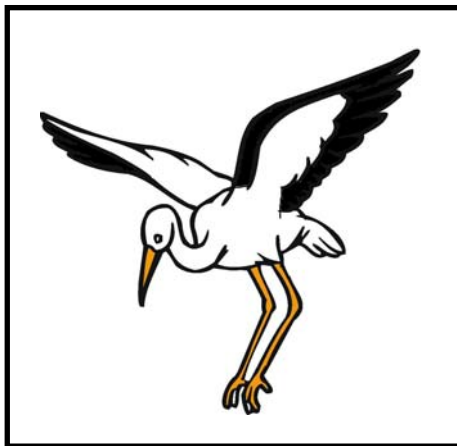
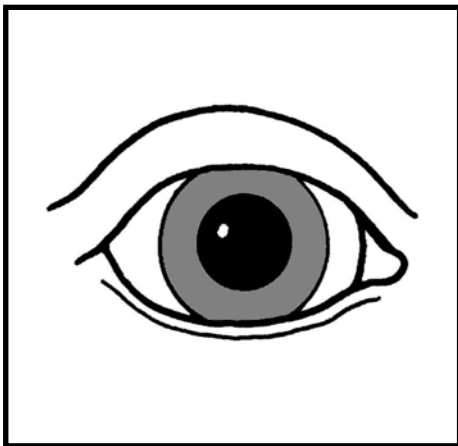
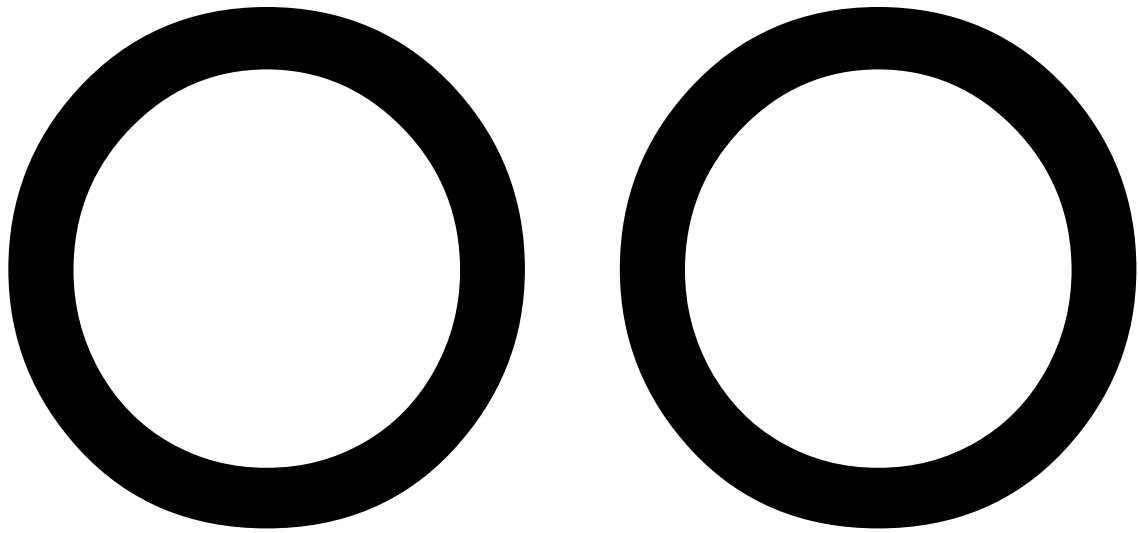

i e

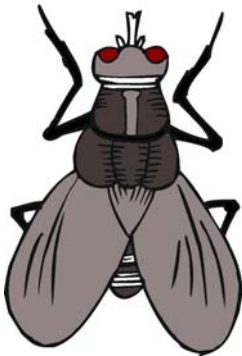
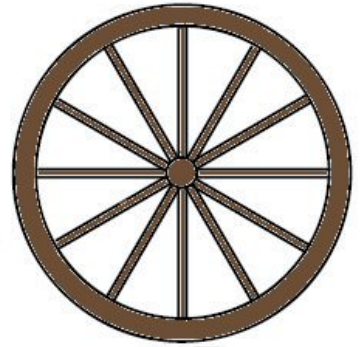

10



u u

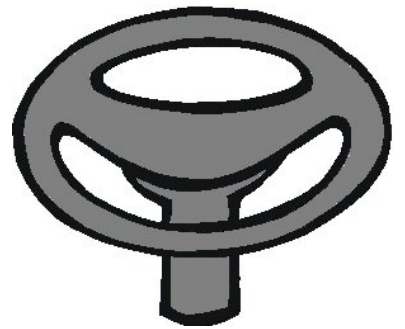
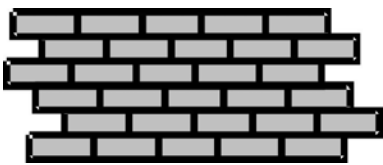

o e

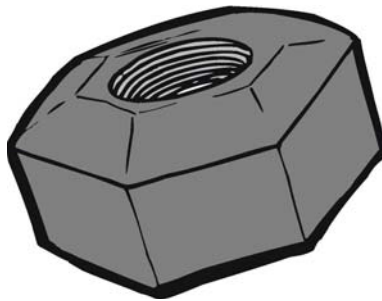

u i

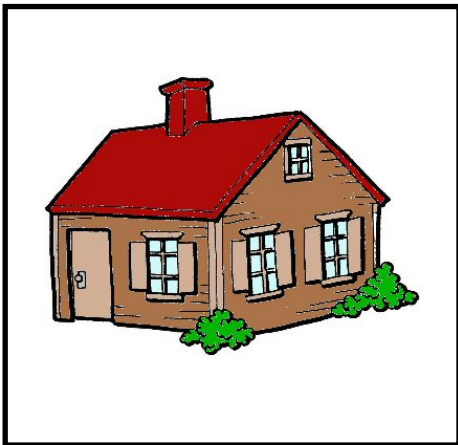
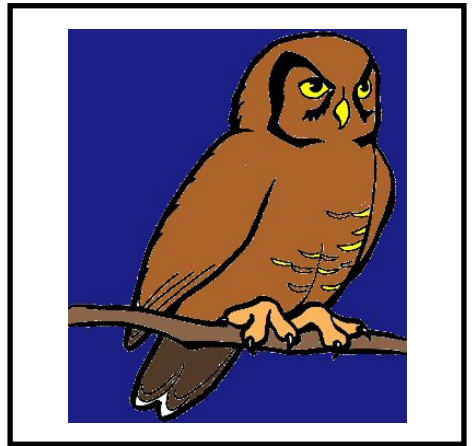
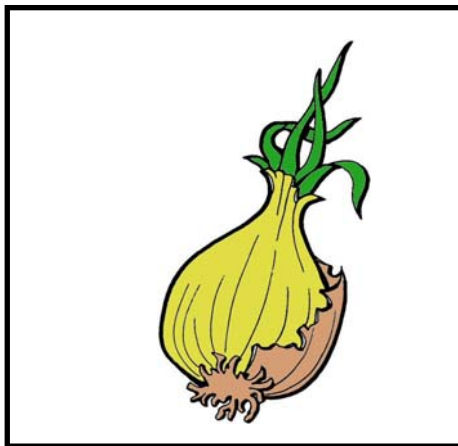
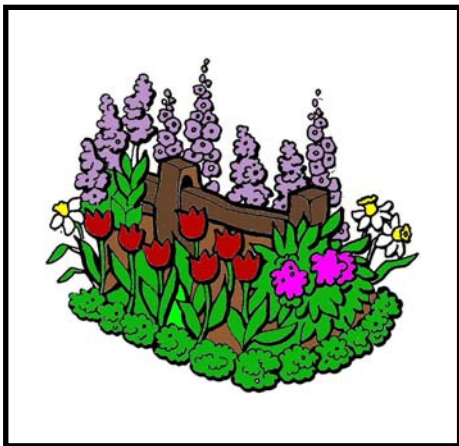

ei

ij

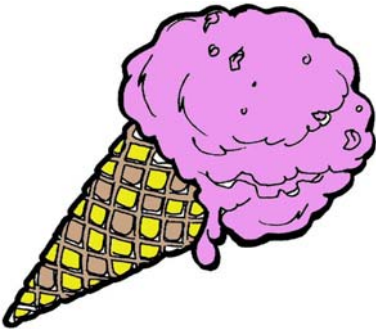
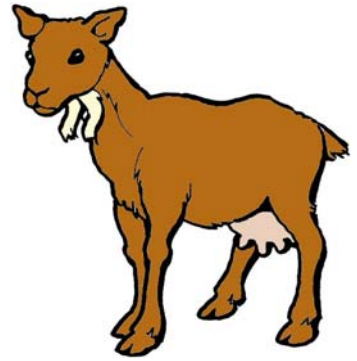
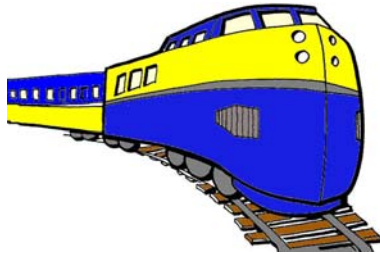
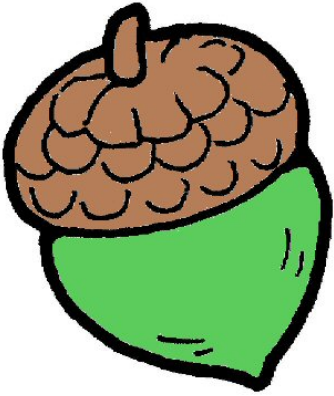

e u



ou

ou

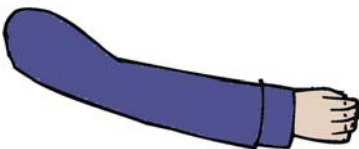
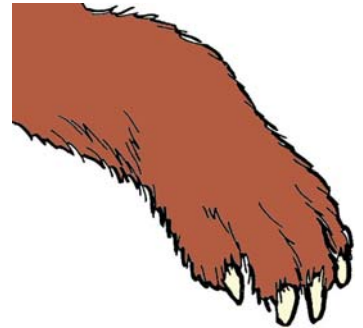

ng

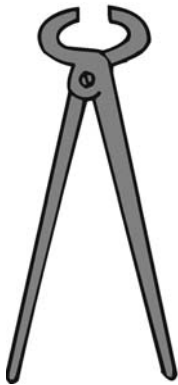
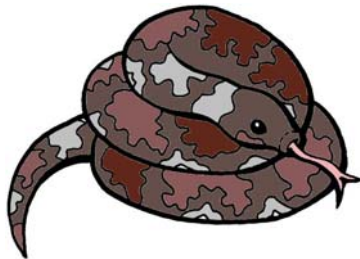

n k

